

# Bushnell®



# MATCH PRO

*RIFLESCOPE OWNER'S GUIDE*

Purpose-built for precision rimfire & NRL22 competition, we developed the Match Pro™ 6-24x50 riflescope starting from a hardened centerfire optic platform, then we gave it all the features you need to compete with confidence and bring home the win. At just \$499.99 (MSRP), the Match Pro is perfect for dominating NRL22's Base Class.



**WARNING: NEVER LOOK AT THE SUN THROUGH THE RIFLESCOPE (OR ANY OTHER OPTICAL INSTRUMENT). IT MAY PERMANENTLY DAMAGE YOUR EYES.**

## MATCHPRO RIFLESCOPE FEATURES

Bushnell® is constantly at the forefront of quality and value, and MatchPro™ riflescopes are no exception. MatchPro riflescopes are built with premium technology. Fully-Multi Coated Optics and waterproof construction offer crisp, bright images in every environment.

All exterior lens surfaces have our new EXO Barrier™ coating (in addition to full multi-coating). EXO Barrier, quite simply, is the best protective lens coating technology Bushnell has ever developed. Added at the end of the coating process, EXO Barrier molecularly bonds to the lens and fills the microscopic pores in the glass. The result is an ultra-slick coating that repels water, oil, fog, dust and debris - rain, snow, fingerprints and dirt will not stick. EXO Barrier is built to last: the bonded coating will not fade with the passage of time or normal wear and tear.

All MatchPro riflescope models feature:

- CLARITY - The best resolution and contrast in all lighting conditions
- FIRST FOCAL PLANE - Ensures accuracy at any magnification
- HIGH LIGHT TRANSMISSION - Ultra Wide Band Coating enables optimum brightness and true color in every lighting condition.
- VALUE - Industry-best technology at an affordable price.

The MatchPro scopes covered in this manual include a 30mm tube, Deploy MIL FFP reticle (*illuminated in model MP6245BF8*), side focus parallax adjustment, and locking turrets with tool-less zero reset.

## KEY ELEMENTS OF A SCOPE

There are four major elements of a scope:

- 1. Objective Lens:** This lens has three functions. First, it permits light to pass into the scope. Second, it determines resolution. Generally, larger lenses allow more light to enter the scope and resolve details better than smaller ones. Finally, it forms an image for the other lenses to magnify to a usable size. The image formed by this lens is upside down.
- 2. Erector System:** The erector system serves three functions. Its primary function is to erect the image (that is, flips the image right-side up) and align it to the reticle. During this process, primary magnification of the image takes place. These two functions are the result of lens action.

The third function is a mechanical one. The erector lenses are housed in a tube that is fixed at one end, while the other end of the tube is free to move and respond to dial adjustments. By moving the erector system, the point-of-aim of the scope is adjusted to match the point-of-impact of the bullet.

- 3. Reticle:** In simple terms, the aiming device around which the scope is built. This element replaces the iron sight system of non-scoped rifles.
- 4. Ocular or Eye Lens:** This element provides the secondary and final magnification of the image.

## MOUNTING YOUR SCOPE

Your new scope, even with its technologically advanced design and features, will not perform at its best if not properly mounted. One of the most important contributing factors to the accuracy of your scope and rifle is the selection of the mount and the care with which mounting is done. Dependable mounts that attach your scope solidly to the rifle will reward you with dependability and consistent accuracy. You should take as much care in selecting a mounting system as you did in selecting your scope.

Remember, not all scopes are compatible with all mounts on all rifles. If there is any doubt in your mind, you should seek the advice of your local retailer or gunsmith.



**WARNING: A RIFLESCOPE SHOULD NEVER BE USED AS A SUBSTITUTE FOR EITHER A BINOCULAR OR SPOTTING SCOPE. IT MAY RESULT IN YOU INADVERTENTLY POINTING THE GUN AT ANOTHER PERSON.**

## PRELIMINARY SCOPE ADJUSTMENTS

Before installing the scope, we recommend you set the focus of the eyepiece to fit your individual visual requirement. Refocusing the ocular distance will result in a sharper reticle focus, an improved optical image, and will help to avoid eye fatigue when using the scope over prolonged periods of time. To refocus, hold the scope about 3 to 4 inches from your eye and point at the open sky or other flatly lit area such as a monotone painted wall.

## PARTS GUIDE



Quickly glance into the scope. If the reticle appears blurred at first glance, it is out of focus. Turn the eyepiece clockwise or counter clockwise several turns. Glance into the scope again to check the sharpness of the reticle. Remember to take quick glances, as the eye will compensate for slightly out of focus conditions with prolonged looks. If the reticle still appears blurred, turn the eyepiece another two or three turns. Repeat this procedure until the reticle is sharp and clearly defined. Unless your eyes undergo a significant change over the years, you will not have to make this adjustment again.

## ATTACHING A MOUNT, RINGS AND SCOPE TO YOUR RIFLE



**WARNING:** BEFORE BEGINNING THE MOUNTING PROCEDURE, BE SURE THE ACTION IS OPEN, THE CLIP OR MAGAZINE IS REMOVED AND THE CHAMBER IS CLEAR. DO NOT ATTEMPT ANY WORK UNTIL YOUR FIREARM HAS BEEN CLEARED AND DETERMINED TO BE SAFE.



**WARNING:** IF THE SCOPE IS NOT MOUNTED FAR ENOUGH FORWARD, ITS REARWARD MOTION MAY INJURE THE SHOOTER WHEN THE RIFLE RECOILS.

In mounting your scope, we recommend that you DO NOT take short cuts as it may lead to damage to either the mounting system or to the scope. Each mounting system will have its own instructions to follow, and it is best to read the instructions first to be sure you understand them and have the necessary tools on hand.

We further recommend that you plan to go through the mounting procedure twice. The first time, to be sure everything fits together and functions properly. On the first run through, please keep the following in mind:

- Before attaching the base, clean the mounting holes in the receiver and the threads of the attaching screws with acetone or any good solvent to free them of oil or grease.
- If the mount manufacturer has recommended the use of a thread adhesive, do not use it on the first mounting trial. Once adhesive has set, it is difficult to demount if anything needs correction.
- Be sure the mounting screws do not protrude into the receiver or the barrel.
- When using dovetail mounts, do not use the scope as a lever when installing the scope. The initial resistance to turning may cause damage to the scope, and is not covered by the warranty. We recommend using a wooden dowel or metal cylinder to seat the rings.
- Be sure the position of the scope does not interfere with the operation of the action.

- Be sure there is at least 0.3cm of clearance between the edges of the rings and any protruding surfaces such as the turret housing (saddle), power selecting ring, and the flare of the objective bell. Also be sure there is at least 0.3cm of clearance between the objective bell and the barrel.
- You should test position the scope for the proper eye relief. The scope rings should be left loose enough so that the scope will slide easily. Variable power scopes should be set at the highest magnification when performing this procedure. Mount the rifle and look through the scope in your normal shooting position.
- Test position the rifle for the proper cheek weld a number of times to ensure that your scope is positioned properly.
- When you are satisfied that everything is okay, demount and start again. This time, seat all screws firmly.

## PARALLAX

You may have noticed that placing your eye at different positions behind the scope's eyepiece causes the reticle crosshairs to appear to move around to different points on your target. This is called "parallax error" (target and reticle are not in the same focal plane), and it becomes more noticeable (and more of a problem) at shorter distances and/or when the scope is set to higher powers. In most cases, parallax will not affect bullet point of impact enough to be of significant concern in large game hunting situations. The MatchPro models covered in this manual provide an adjustment for parallax compensation (side focus knob), which works by moving an optical element until the target (based on its distance) appears in the same plane of focus as the reticle. Your MatchPro scope can be focused down to as close as 10 yards.

## USING THE SIDE FOCUS

Your MatchPro scope has a parallax compensation design which uses a movable lens back near the reticle, so the adjustment can be made with a "side focus" knob placed next to the windage and elevation adjustments. Just line up the estimated distance to your target with the index dot, and you will eliminate the aiming errors caused by parallax. After setting the side focus, you can double check by moving your head around from side to side behind the eyepiece-the point of aim should not shift if the side focus is correctly set. An alternative method is to look through the scope and turn the side focus knob until the target, at whatever range, is sharply focused.

## PRELIMINARY SIGHTING-IN

You can save a significant amount of expense and frustration by pre-sighting the scope to the rifle before you take it to the range for zeroing.

There are two basic methods that can be used for pre-sighting your scope. Method one is to use a Bushnell® Bore Sighter (laser, magnetic or standard). The use of a Bore Sighter saves time and ammunition and is the system most often used by gunsmiths.

The second method is traditional bore sighting. The Deploy reticle is intended to be sighted in at 100 yards, and is calibrated in MIL (Miliradians). The reticle has wider markings every 1 Mil. The reticle is located in the first focal plane, so the range and windage marks can be used for reference at any magnification setting.

## BORE SIGHTING METHOD

1. Place a target at 100 yards.
2. Remove the bolt from the rifle.
3. Place the rifle on sandbags or a shooting rest.
4. Set the scope to its lowest magnification.
5. Peer through the bore from the receiver and adjust the position of the rifle to center the target bull's eye in the bore (*Fig. A*).
6. Without moving the rifle, look into the scope and note the position of the reticle on the target. Pull the turret up (elevation) or out (windage) to unlock it before adjusting. Grasp the turret and turn it in the appropriate "UP" (and/or "L") direction indicated by the arrows to center the reticle on the bull's eye (*Fig. B*). Each "click" or increment on the Adjustment Scale Ring will change the bullet impact by the laser engraved value on the top of your scope model's turret caps. 0.1 Mil corresponds to 0.1 Mil inch at 100 yards, 0.2 Mil at 200 yards, 0.3 Mil at 300 yards and so on.

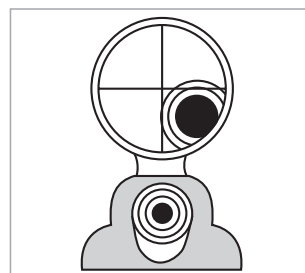

**Fig. A**  
Reticle not in alignment

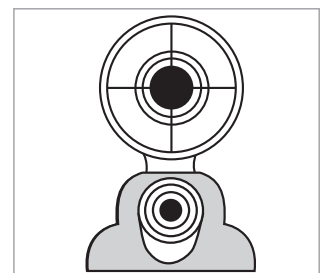

**Fig. B**  
Reticle in alignment



## FINAL SIGHTING-IN



**WARNING:** SINCE THIS PROCEDURE INVOLVES LIVE FIRE, IT SHOULD BE DONE AT AN APPROVED RANGE OR OTHER SAFE AREA. CHECK BORE FOR OBSTRUCTIONS. AN OBSTRUCTED BORE MAY CAUSE INJURY TO YOU AND OTHERS NEARBY. EYE AND EAR PROTECTION IS RECOMMENDED.

1. From a steady rest position, fire two or three rounds at a 100 yard target. Note the impact of the bullet on the target and adjust the windage and elevation dials as needed.
2. To move the bullet impact, turn the windage and/or elevation adjustments in the direction on the dials that corresponds to where the impact point falls on the target (for example, if test shots are hitting low, adjust elevation "down"). The adjustments on your riflescope model are marked in Mills (miloradians), and the point of impact at 100 yards will change by .1 MIL for each click of the windage or elevation adjustment. One full revolution of the adjustment=10 MIL.
3. When the impact on the 100 yard target is satisfactory, switch to a target set at the desired distance for final zeroing. Set the magnification to the desired power on variable power models.

## RESETTING THE TOOL-LESS ZERO RESET LOCKING TURRETS

After zeroing in your rifle (refer to photos below):

1. Push down on the turret (windage or elevation), placing the turret in the locked position.
2. Unscrew the top cap of the turret (rotate it counterclockwise), and pull it off of the turret. Set it aside.
3. Pull up the loose turret (you may remove it from the scope if desired, but it's not necessary as long as you can freely rotate it). Position it so that zero ("0") on the turret's scale is lined up with the index mark on the scope. Press down the turret until it locks in place.
4. Replace the top cap on the turret, rotating it clockwise until finger tight (do not overtighten). Your MatchPro scope is now zeroed.



## VARIABLE POWER ADJUSTMENTS

To change magnification, simply rotate the Power Change Ring to align the desired number on the power scale with the index dot. When still-hunting or stalking game, a variable scope should be set to the lowest power. You then have the widest field of view for quick shots at close range. Higher powers should be reserved for precise long-range shots.

## ILLUMINATED RETICLE OPERATION/BATTERY REPLACEMENT (MODEL MP6245BF8 ONLY)

The red dot at the center of the reticle crosshairs is illuminated. The illumination adjustment dial is located at the end of the side focus knob. To increase the brightness, set the control to a higher number (opposite the white index mark). To turn off the illumination, and when storing the scope, set the dial to any of the "Off" positions (dots) between each numbered illumination setting.

To replace the battery, remove the cap (see photo, right) on the end of the brightness adjustment control knob using a coin, and insert a CR2032 battery with the "+" mark facing up.

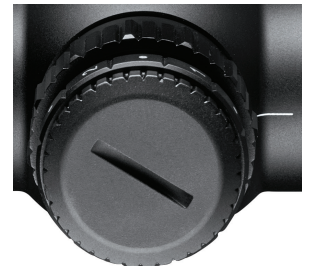

## THE BUSHNELL DEPLOY™ MIL FFP RETICLE

The Bushnell® Deploy™ Mil reticle provides a very accurate means of range estimation. The mil markings also allow precise leads for moving targets and exact compensation for shooting in a crosswind. There are hashmarks at every 0.5 Mil for accurate elevation holdover. With accurate ballistic calculations, the Deploy Mil reticle delivers accurate shots, every time.

## COMPENSATING FOR THE EFFECTS OF WIND / AIMING POINTS

The Deploy Mil reticle also incorporates windage hold points on the horizontal axis in the reticle to aid in compensation for the wind's effect on bullet trajectory. Windage hold marks are spaced at 0.5 Mil intervals, with longer marks every 5 Mil. The first few 1 Mil marks on the vertical (elevation) axis are also useful for windage purposes, as each mark is 2 Mil in width. To use the windage hold marks, first determine a range to the target using a Bushnell laser rangefinder (Prime, Nitro, etc.). Once the range to target is available, an estimate of wind velocity must be made. The reticle can then be elevated to the correct yardage mark and then moved horizontally into the wind direction using the Mil wind marks on the Deploy reticle in order to compensate for bullet drop and wind drift. Illustrations of the reticle markings are shown on the next page.

**DEPLOY™ MIL RETICLE  
DIMENSIONAL SPECS**

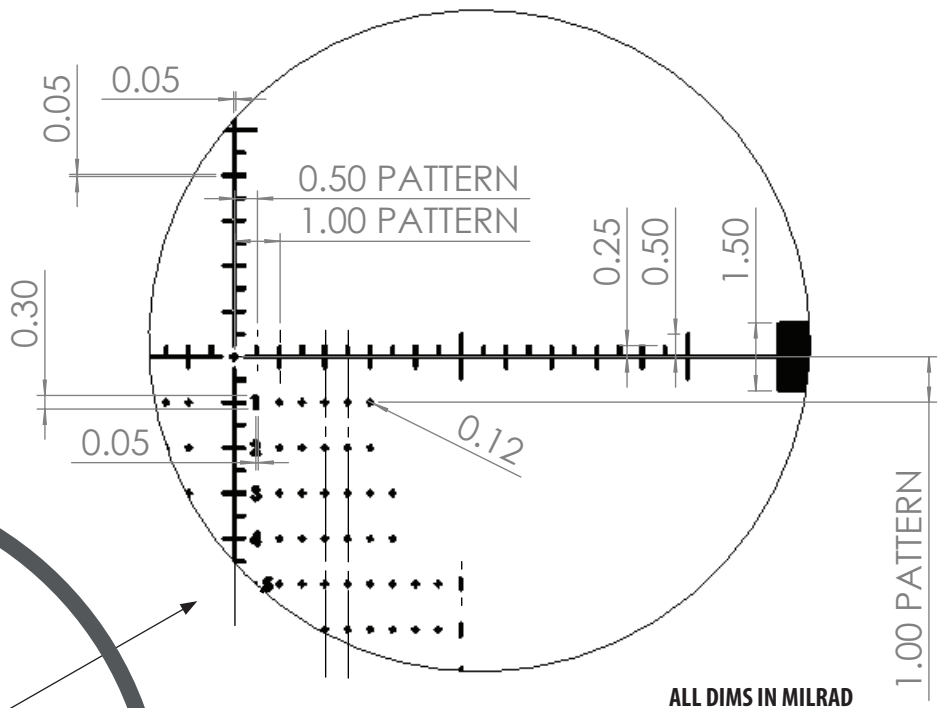

ALL DIMS IN MILRAD

**THE BUSHNELL DEPLOY™ MIL RETICLE (FFP)  
(NON-ILLUMINATED VERSION)**

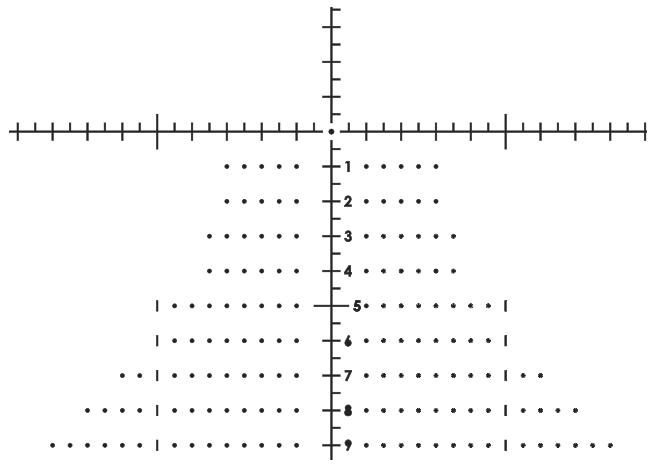
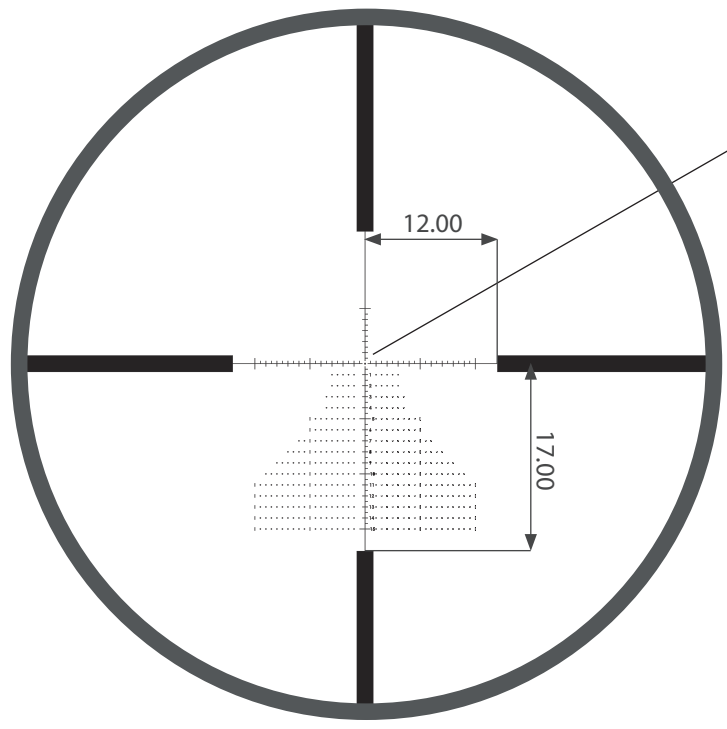

**THE BUSHNELL DEPLOY™ MIL RETICLE (FFP)  
(ILLUMINATED VERSION)**

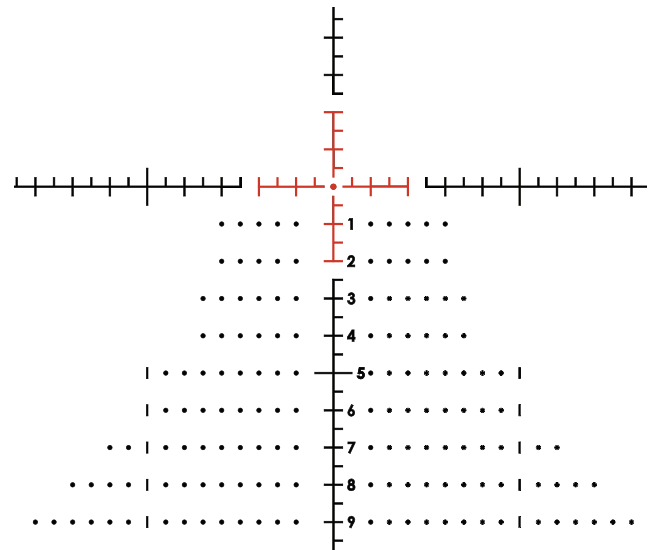
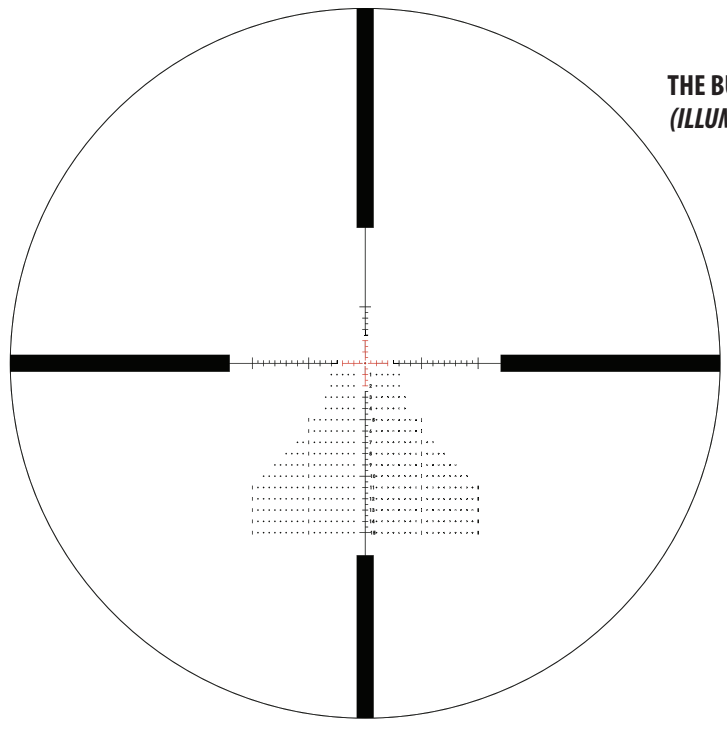

The Deploy Mil reticle is designed to be used with any caliber, bullet weight and velocity. Simply run the ballistics with a known velocity, BC, zero distance and environmental data to get your Mil drop points at various distances.

### RANGING WITH YOUR MIL-DOT RETICLE

The mil is an angular measurement -- 1/6400th of a circle -- which equals almost precisely one yard at 1000 yards, or one meter at 1000 meters. This proportional relationship makes possible a simple formula to compute distances:

$$\frac{\text{The Measured Object's Width or Height in Yards} \times 1000}{\text{Object's Width or Height in Mils}} = \text{Range in Yards}$$

This formula works equally well with meters, but don't mix meters and yards: Measure the object in yards to find the distance in yards, use meters to yield distances in meters.

Looking through your scope, select an object at the distance you want to range -- an object whose width or height you know or can estimate accurately. Man-made objects of uniform size, such as fenceposts, are best, but any object of known dimensions will do. Measure the object's height or width carefully in mils, compute it according to the formula and you will find its range. Support your rifle and be precise when measuring objects; any measuring error causes an error in the computed range. Equally, a mistake in estimating the object size results in a proportional range error.

Here's an example: A coyote is sunning himself in a snowfield beside a fencepost; having crossed the fence earlier, you know that the post is about four feet high, or 1.33 yards. The fencepost measures 2.5 mils in your reticle.

$$\frac{1.33 \text{ yards} \times 1000}{2.5 \text{ mils}} = \frac{1330}{2.5} = 532 \text{ Yards}$$

### ALTITUDE AND TEMPERATURE

Ballistic charts published by ammunition manufacturers are based upon standard sea level conditions. When sighting in, it is well to keep in mind that altitude and temperature affect trajectory. It is best to sight-in under the same conditions in which you will be hunting.

### CARING FOR YOUR RIFLESCOPE

Your scope needs very little maintenance. Exterior metal surfaces should be kept clean. A light dusting with a slightly dampened soft cloth is enough in most cases.

Your new scope features windage and elevation turrets that are completely sealed against water intrusion.

We also recommend that lens covers be kept in place when the scope is not being used. Lenses should be inspected regularly and kept clean at all times. Dust, dirt, and fingerprints that collect on the lens surfaces will severely degrade image quality, and if left unclean for long periods, the anti-reflection coating could be damaged. Although lens cleaning is not difficult, it does require care and some patience.

- Start with a lens brush or a small, soft bristle paintbrush. Gently whisk away loose dirt particles.
- Next, use an ear syringe or bulb aspirator (available in most drug stores) to blow remaining dirt or dust from lens surfaces.
- If further cleaning is needed, use a dry, soft lint-free cloth. Very gently wipe the lens, starting at the center using a circular motion, then working outward to the edge.
- If this has not corrected the problem repeat the process using condensation from your breath.

### Technical Specifications *(\* model MP6245BF8 has illuminated reticle)*

SKU	Mag x Obj. Diam.	Reticle (Illuminated)	Turrets (Tool-less)	Elev. Travel (Mil)	Travel per Revolution	Tube Diameter (mm)	Parallax (Yards)	Eye Relief, Max Mag.	Field of View @ 100 Yds (Ft)	Length (in)	Weight (oz)
MP6245BF2	6-24x50	Deploy MIL FFP	Exposed, Locking	18	10	30	10	95mm	19-5	14.5	29.8
MP6245BF8	6-24x50	Deploy MIL FFP *	Exposed, Locking	18	10	30	10	95mm	19-5	14.5	29.8

## DO YOU NEED TO SEND YOUR SCOPE TO US?

Before returning your scope for service, you should check the following points to make sure the problem is with the scope:

- Check the mounting system and rings for looseness or misalignment.
- Check to be sure the barrel and action are properly bedded and all receiver screws are tight.
- Check to be sure the mounting system allows sufficient clearance between the objective bell and the barrel.
- Check to be sure you are using the same type and weight ammunition that you used for sighting-in.



NO RECEIPT  
REQUIRED



FULLY  
TRANSFERABLE



WORKMANSHIP  
COVERED



MATERIALS  
COVERED

### COVERAGE YOU CAN COUNT ON

**All Bushnell products are engineered to deliver to your expectation and manufactured to withstand the rigors of the outdoors for the lifetime of the product. In the event that our product fails you, we will stand behind it and repair it at no cost to you. If we can't repair it then we will replace it with a product of equal or better value. No receipt required and fully transferable.**

All Bushnell® products carry a product lifetime warranty against defects in workmanship or materials. Product lifetime is defined as 30 years for riflescopes, 20 years for binoculars and spotting scopes, 5 years for electro-optics (laser rangefinders, red dot sights, reflex sights, speed gun radars, night vision, GPS) and electronic components (illuminated reticles) and 2 years for trail cams. Coverage period start date is determined by proof of purchase or manufacturing date of the product. This warranty does not cover cosmetic damage; damage caused by failing to properly maintain the product; loss; theft; damage as a result of unauthorized repair, modification, or disassembly; intentional damage, misuses, or abuse. This Warranty will be void if the date stamp or other serialization codes have been removed from the Product. We may replace your product with a product of equal or better physical condition.

To view the full warranty and download the details of the warranty, click this link: <https://www.bushnell.com/bu-warranty.html>

To submit a repair request or check the status of a repair ticket: <https://service.bushnell.com/s/>

Alternatively, you can request a copy of the warranty by calling us at 1-800-423-3537 or writing to us at one of the following addresses:

IN U.S.A. Send To:

Bushnell Holdings, Inc.  
Attn.: Repairs  
9200 Cody  
Overland Park, Kansas 66214

IN CANADA Send To:

Bushnell Holdings, Inc.  
Attn.: Repairs  
140 Great Gulf Drive, Unit B  
Vaughan, Ontario L4K 5W1  
Canada

For products purchased outside the United States or Canada, please contact your local dealer for applicable warranty information.

This warranty gives you specific legal rights and you may also have other rights, which vary from state to state.

We warrant that during the warranty period, with proper use and care, the product will be free from defects in materials and workmanship and will meet represented performance standards as defined by the warrantor in its sole discretion.

The remedies described herein are your sole and exclusive remedies and our entire liability for any breach of this warranty. Our liability shall under no circumstances exceed the actual amount paid by you for the defective product, nor shall we under any circumstances be liable for any consequential, incidental, special or punitive damages or losses, whether direct or indirect.

Some states do not allow the exclusion or limitation of incidental or consequential damages, so the above limitation or exclusion may not apply to you.

Our responsibility for defective goods is limited to repair or replacement as described in this warranty statement.



# Bushnell®

©2020 Bushnell Outdoor Products  
Bushnell,™, ®, denote trademarks of Bushnell Outdoor Products  
[www.bushnell.com](http://www.bushnell.com)

9200 Cody, Overland Park, KS 66214